

PENDELSICHERUNG

CORD GUIDING - CÂBLES DE GUIDAGE

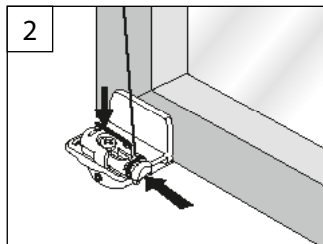

5

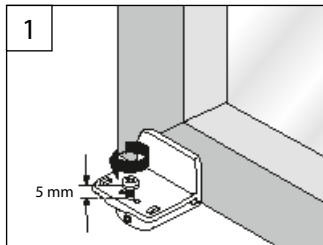
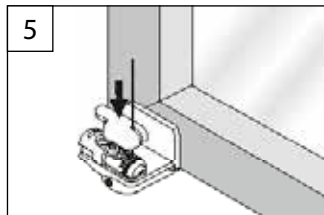
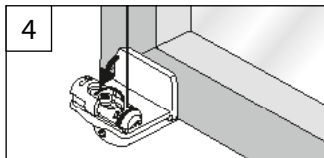
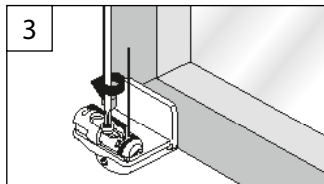

6



Plissee

Pleated blinds – Stores plissés

Klemmträger „Halteplatte“

Block holder „Lock plate“

Support pour fenêtres PVC « Plaque de support »

Montage- und

Bedienanleitung

Assembly and operating instructions

Notice de montage et mode d'emploi



10 / 2014

technische Änderungen bleiben vorbehalten

subject to technical change

sous réserve de modifications techniques



04046046224020

A Montage

Fixation – Montage

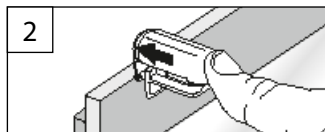
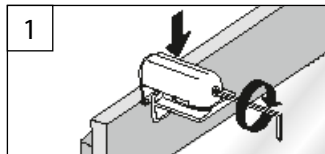

1

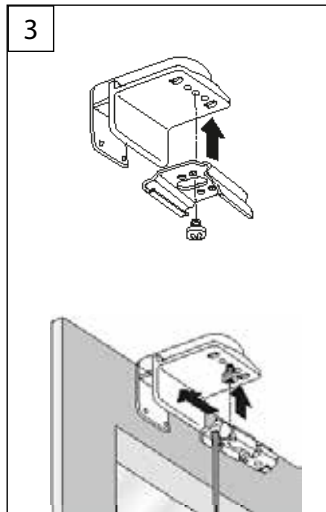

2

VS1, VS2, VS3, VS 4 SLOPE1, VS4 SLOPE 2, VS SD

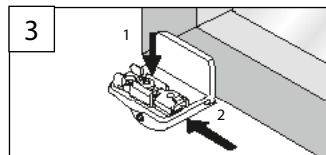
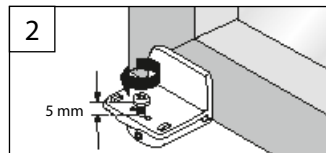
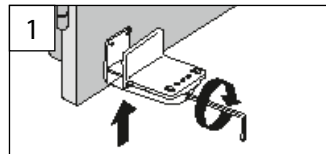

3

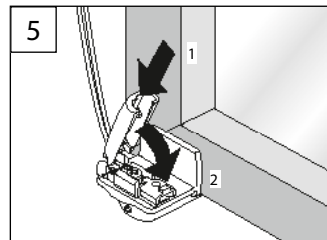
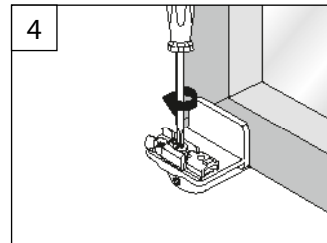

4